

Control del motor

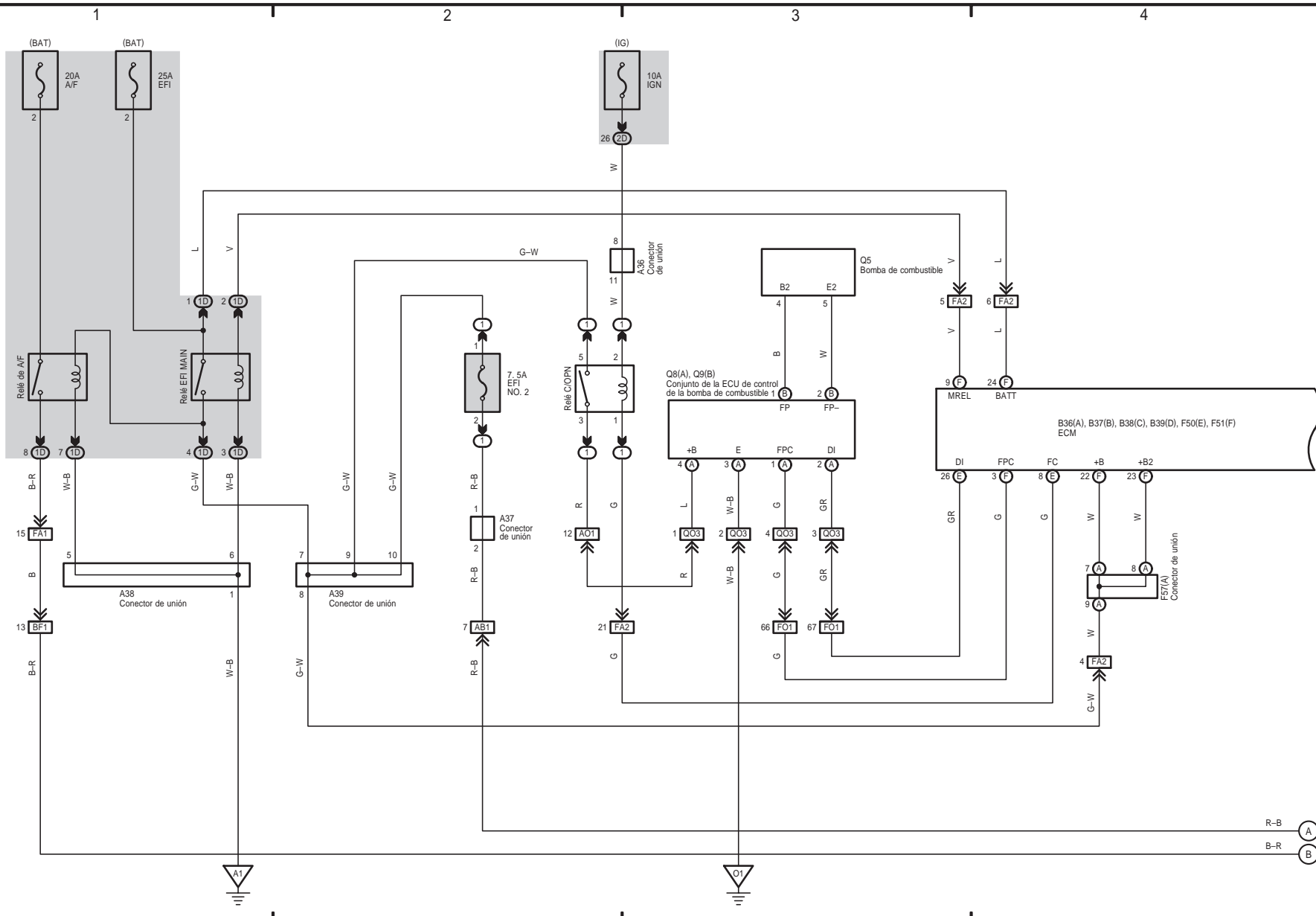

4RUNNER (EM1442S)

Control del motor

* 1 : Protegido

5 6 7 8

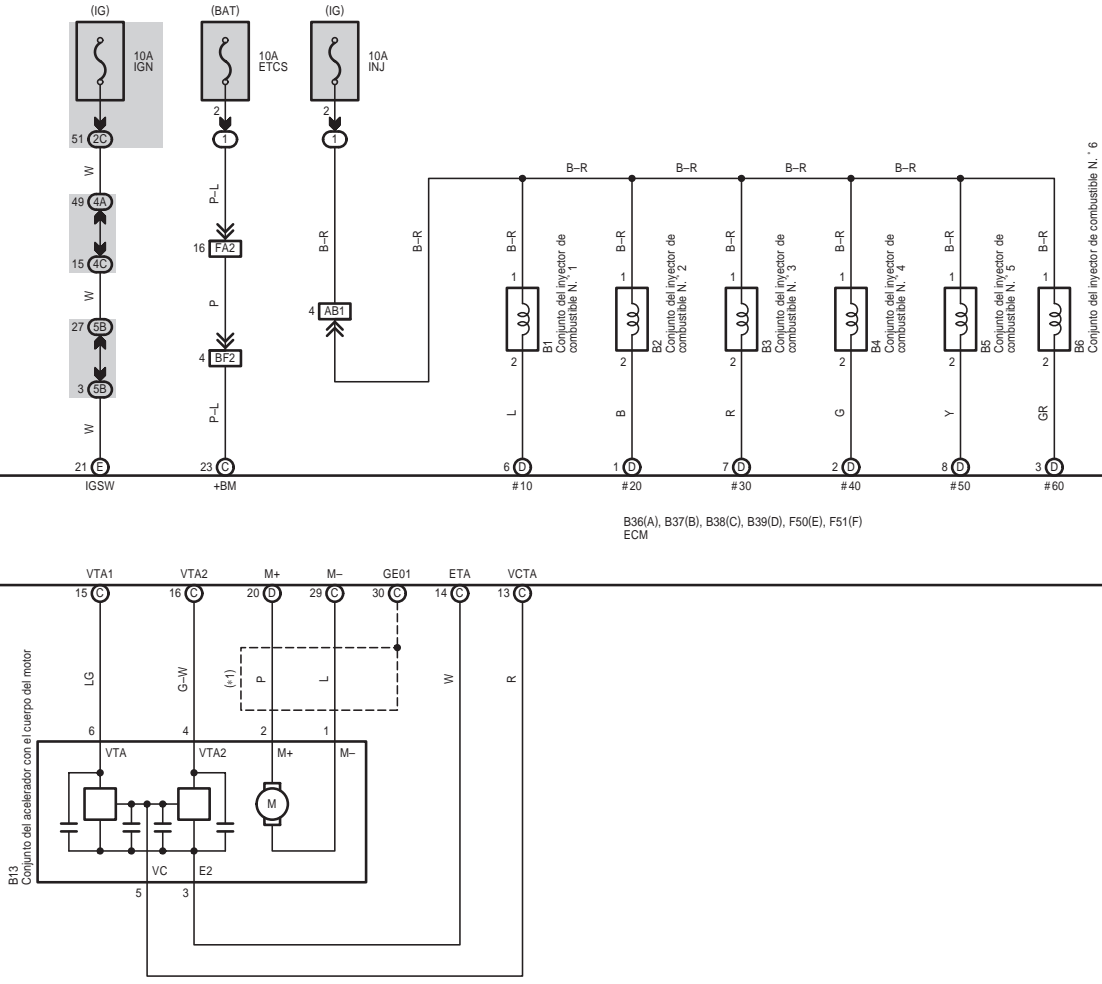

4RUNNER (EM1442S)

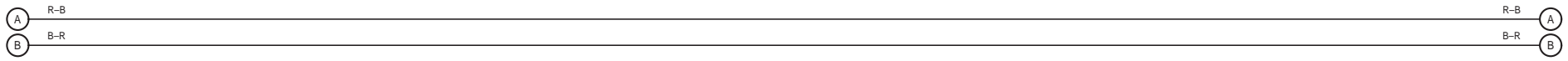

Control del motor

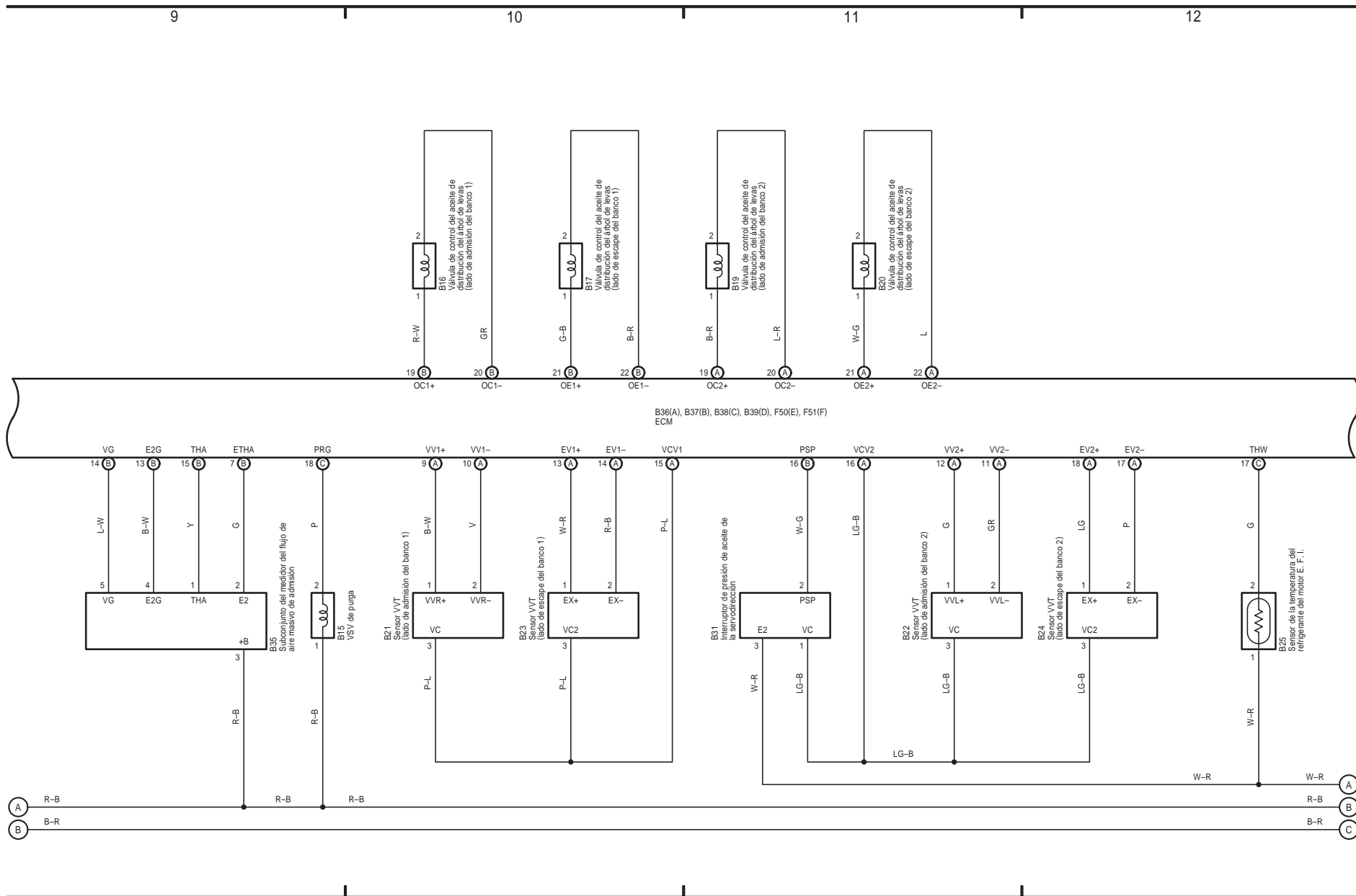

Control del motor

* 1 : Protegido

13

14

15

16

Conjuntos de la bobina de encendido <4-2> <4-3> <4-4>

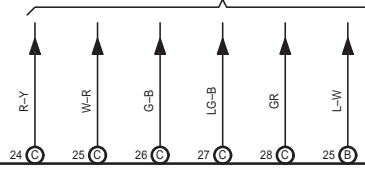

Conjunto del generador <3-3>



Conjunto del interruptor de la posición de estacionamiento punto muerto <2-3>



Conjunto del interruptor de la luz de parada <11-1>



DLC3 <9-2>



ECU de control de la tracción en las cuatro ruedas <14-2>



Conjunto del medidor de combinación <26-1>



Conjunto del amplificador del AIC <27-5>



Sistema de comunicaciones múltiple (CAN) <8-6>



Conjunto de la ECU de la lavadora <7-1>



B36(A), B37(B), B38(C), B39(D), F50(E), F51(F)
ECM

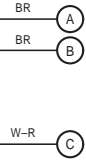
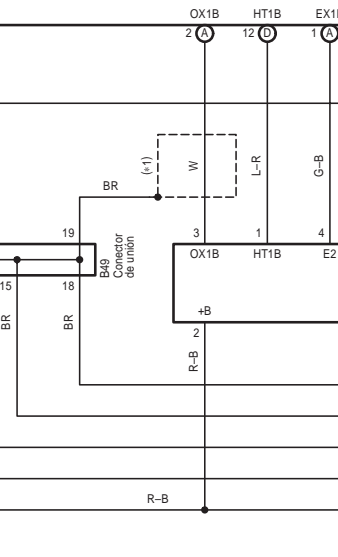
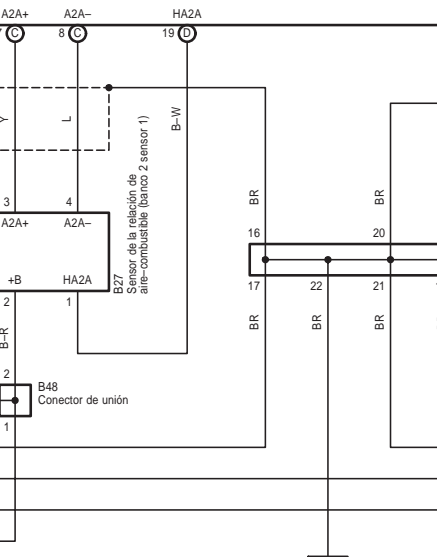
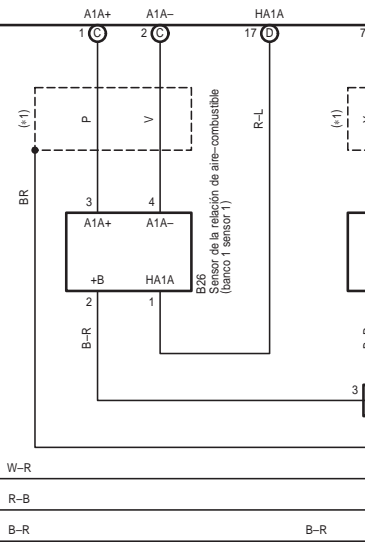

4RUNNER (EM1442S)



Control del motor

Indicador de ECT y de A/T

* 1 : Protegido

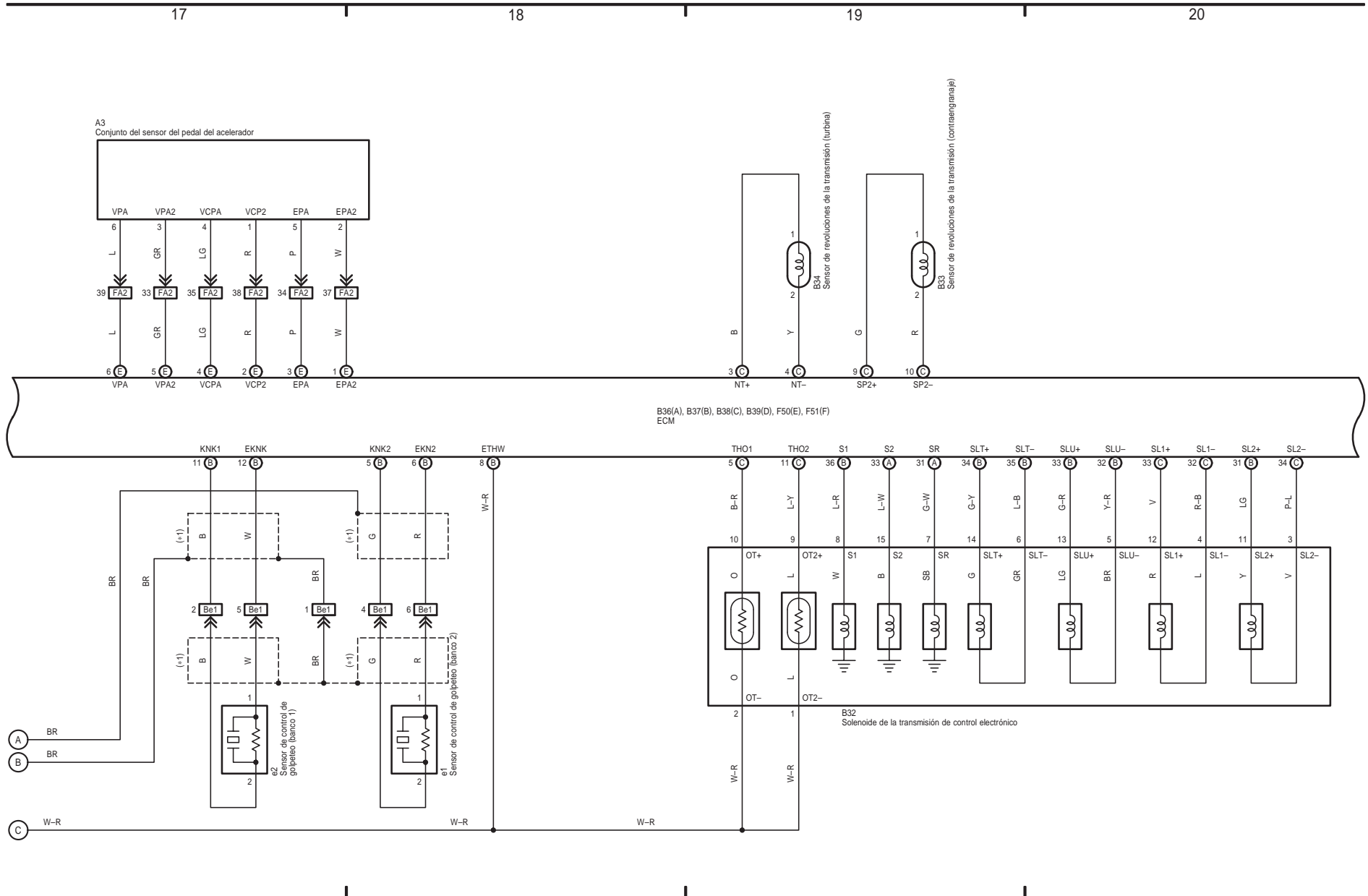

Control de crucero

* 3 : con control de crucero

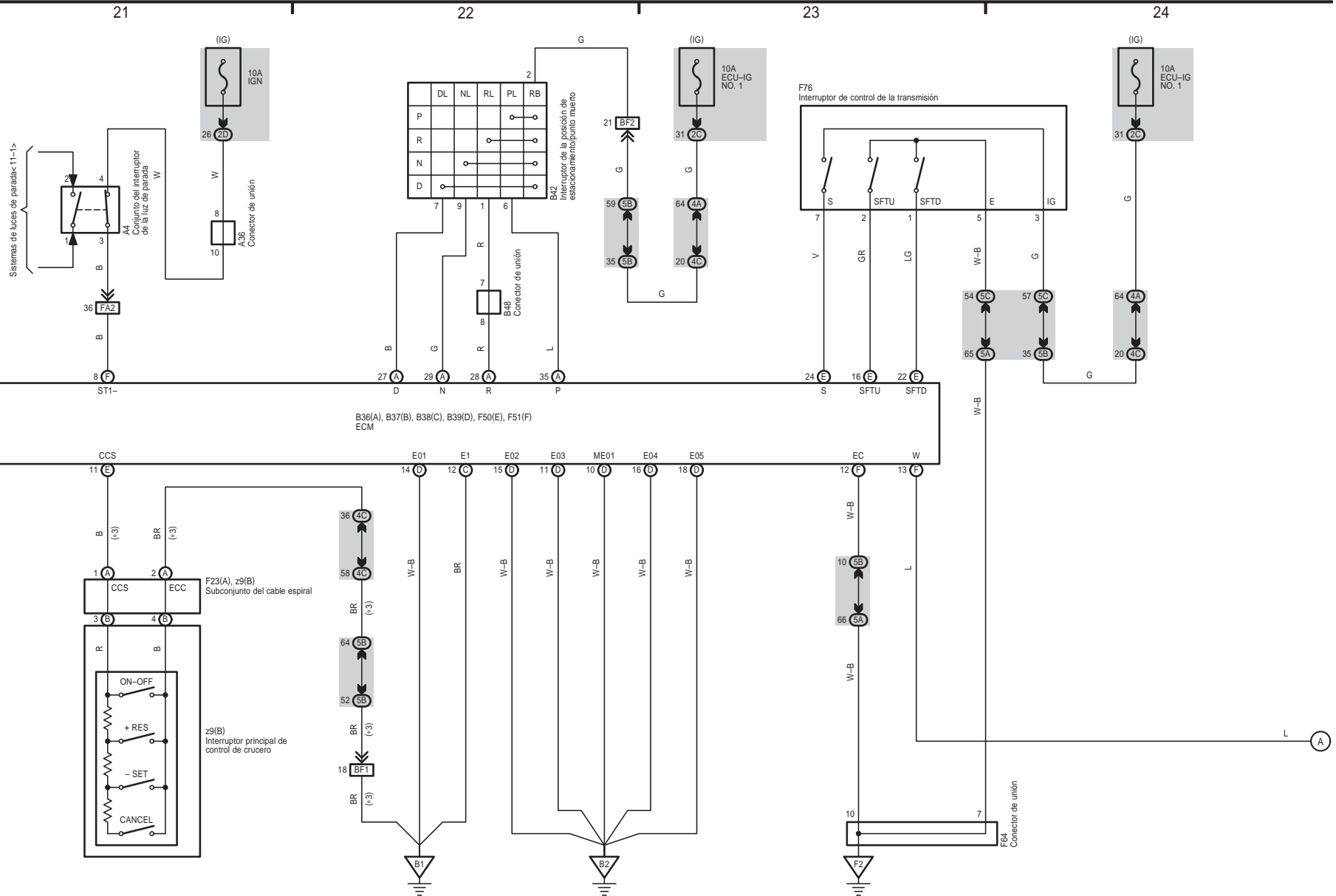

4RUNNER (EM1442S)

Control de cruceo

25

26

27

28

4RUNNER (EM1442S)

M DIAGRAMA DE CONEXIONES ELECTRICAS GENERAL

